

STEARNS

OWNER'S MANUAL FOR
STEARNS
INFLATABLE KAYAK

PIVOT™ (BOAT)

~~PIVOT™ (BOAT)~~

IMPORTANT!

PLEASE READ THIS MANUAL CAREFULLY BEFORE USING THE KAYAK. IT CONTAINS IMPORTANT INFORMATION THAT MAY BE NECESSARY TO PREVENT INJURY OR DAMAGE TO YOUR KAYAK.



Pivot
(00001)

Stearns, Inc.
60 Cloud Minnesota 56302 U.S.A.
Phone (800) 452-1043 or 1-800-607-5001
Fax (800) 267-4925
www.stearns.com



NO POSTAGE
NECESSARY
IF MAILED
IN THE
UNITED STATES

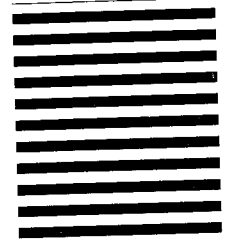

BUSINESS REPLY MAIL

FIRST CLASS PERMIT NO. 558 ST. CLOUD, MINNESOTA

POSTAGE WILL BE PAID BY ADDRESSEE

STEARNS[®] INC
PO BOX 1498
ST. CLOUD, MN 56302-9743



1. INTRODUCTION

This manual has been compiled to help you operate your craft with safety and pleasure. It contains details of the craft, the equipment supplied or fitted, its systems, and information on its operation and maintenance. Please read it carefully and familiarize yourself with the craft before using it.

If this is your first craft, or you are changing to a type of craft you are not familiar with, for your own comfort and safety, please ensure that you obtain handling and operating experience before assuming command of the craft.

PLEASE KEEP THIS MANUAL IN A SAFE PLACE, AND HAND IT OVER TO THE NEW OWNER WITHIN YOU SET THE CRAFT.

2. WARRANTY

Complete and return the Warranty Registration Form found on the back of this Owner's Manual.

2.1 MODIFICATIONS

Because of the possibility of interference with the factory design integrity of the kayak, owner modifications to the kayak are not recommended.

Unauthorized modifications to the kayak could compromise safety, design integrity or warranty coverage.

3. BOATING SAFETY



This is the safety alert symbol. It is used to alert you to potential personal injury hazards. Obey all labels, instructions that follow this symbol to avoid possible injury or death.

! DANGER !

Indicates an imminently hazardous situation which, if not avoided, will result in death or serious injury or substantial property damage.

! WARNING !

Indicates a potentially hazardous situation which, if not avoided, could result in death or serious injury or property damage.

! CAUTION !

Indicates a potentially hazardous situation which, if not avoided, may result in property damage.

CAUTION

Used without the safety alert symbol indicates a potentially hazardous situation which, if not avoided, may result in property damage.

NOTICE

Indicates installation, operation or maintenance information which is important but not hazard-related.

The precautions listed in this manual and on the craft are not all-inclusive. If a procedure, method, tool or part is not specifically recommended, you must satisfy yourself that it is safe for you and others, and that the craft will not be damaged or made unsafe as a result of your decision. **REMEMBER - always use common sense when padding YOUR KAYAK!**

3.1 Boating Regulations

The U.S. Coast Guard is the authority of the waterways; they are there to help the boating public. State boating regulations are enforced by local authorities. You are subject to marine traffic laws and "Rules of the Road" for both federal and state waterways; you must stop if signaled to do so by enforcement officers.

There are many pamphlets, prepared by the Coast Guard, available to you. These pamphlets explain "Rules of the Road," signal lights, buoys, safety equipment, international and inland regulations and much more than is presented in this manual. For more information contact your local U.S. Coast Guard Unit or call the Coast Guard Customer Info line at 1-800-368-5647.

3.1.1 Boat Safety Labels

Your kayak is affixed with various safety labels at the time of manufacture. These labels appear at specific locations on the craft where safety is of particular concern. Safety labels must remain legible and should not be removed. If you suspect a label is missing or one becomes damaged, contact STEARNS® at 320-252-1642 or 1-800-697-5801.

3.1.2 Registration

The U.S. Coast Guard requires that all power boats operated on the navigable waters of the United States must be registered in the state of main use; also, many States require registration in that state whenever boating on waters within their state boundary. Always contact your state boating authorities (and neighboring states) for registration information on boats.

Once you have been issued a number, it is best to affix it on the boat by printing it on the material with a permanent ink marker.

3.1.3 Education

This manual is not intended to provide complete training on all aspects of boat operation. We strongly recommend that all operators of this boat seek additional training on boat handling and safety, and provide safety training for all passengers.

3.2 RESPONSIBILITIES OF THE OPERATOR

IMPORTANT

Users of this product agree by their use to accept the inherent risks involved in this water sports activity and agree to follow all instructions, DANGERS, CAUTION, and WARNINGS carefully before using their STEARNS® kayak.

- **READ OWNER'S MANUAL:** Improper Use May Cause Injury or Death. Pay close attention to items marked "DANGER," "WARNING," "CAUTION" or "NEVER."

- Use the kayak in a **SAFE** and **SOBER** manner, taking all reasonable precautions.
- Each passenger **MUST** Wear an approved personal flotation device (PFD). All safety equipment & PFDs must be in good condition and suitable for your kayak and passenger use.
- **THIS KAYAK IS NOT A PERSONAL FLOTATION DEVICE.**
- Follow all inflation and care instructions.
- **BE AWARE** of local boating regulations and follow them.
- **BE AWARE** of your environment, water currents, tides, weather, traffic and other potential hazards in the water and surroundings.
- **DO NOT** use this kayak **UNDER** the **INFLUENCE** of **DRUGS** or **ALCOHOL**.
- **DO NOT** use this kayak if you suspect a tear or hole. **IT MAY BE UNSAFE.**
- **USE CAUTION** when entering or exiting the kayak. Keep your weight centered and distribute the weight of the gear and passengers evenly.
- **DO NOT** allow children to use this kayak without the supervision of an adult or someone who is experienced in its safe use.
- **DO NOT** tow this kayak.
- **Seek shelter from open water if there is threat of lightning.**

3.3 RESTRICTED AREAS

Before kayaking, check with Local, State and Federal authorities to identify restricted areas. Because of the threat of terrorism, the U.S. Coast Guard has and will continue to implement strict limits on watercraft near U.S. Navy and Coast Guard ships and other potential targets.

4. SPECIFICATIONS

- Pivot™ Kayak (B527)**
 Length 9' (274 cm)
 Beam 36" (91 cm)
 Dry Weight: 31 lbs (14 kg)
 Max. Persons Capacity 1 person
 Max. Persons & Gear Capacity 250 lbs NMMA
 115 kg (253 lbs.) ISO
 Recommended Pressure
 Main chamber: 2.0 psi (0.14 bar)
 Floor chamber: 1.0 psi (0.07 bar)

4.1 CAPACITY

The person/load capacity is determined by the availability of proper seating on the kayak. Acceptable seating determines the number of passengers, not the overall load capacity.

Pivot™ capacity label

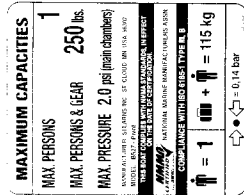

NMMA/ISO



WARNING

Do not exceed the certified maximum capacities under any circumstances. Overloading will reduce freeboard and increase the likelihood of swamping, especially in heavy seas. Overloading causes handling to become sluggish, making it difficult to react quickly.

4.2 FEATURES

Pivot™ Kayak

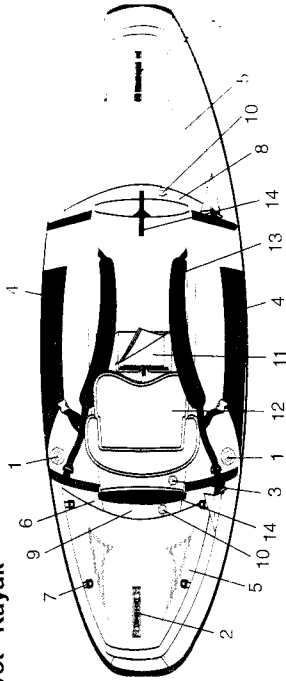

1. Main chamber valve
2. Carrying/grab handles
3. Floor valve
4. Knuckle abrasion guards
5. Spray deck
6. Chamber access zippers
7. Tie down D-rings
8. Front buoyancy chamber/foot rest
9. Rear buoyancy chamber/dry bag
10. Buoyancy Chamber Valves
11. Map pocket
12. Four-way adjustable/secured seat with buckles
13. Adjustable thigh straps
14. Chamber bracing system

5. PREPARING YOUR STEARNS® INFLATABLE KAYAK

The STEARNS® Inflatable Kayak is designed for recreational use and can be used in a number of settings. Every usage has its own set of required skill levels and dangers. Be sure you are prepared for each use before attempting it and you understand the inherent dangers.

Inflation Setup

Use a STEARNS® "bellows" style foot pump (Model B502) or equivalent pump to inflate your boat. Use caution not to over inflate your boat. (Pump not included)



WARNING

NEVER USE COMPRESSORS, CO₂ OR COMPRESSED AIR. DO NOT OVER-INFLATE THE FLOOR OR THE SIDE CHAMBERS.

5.1 QUICK START TO INFLATING YOUR KAYAK

Follow steps below. If you do not understand or are unfamiliar with the following quick start steps, refer to the following pages for detailed explanation.

1. Unfold and lay out kayak on flat, level ground

DO NOT OVER INFLATE FLOOR CHAMBER beyond 1.0 psi or 0.07 bar
 2. First inflate the floor chamber until chamber feels semi-firm. Do not over inflate (see page 11)

DO NOT OVER INFLATE MAIN CHAMBERS beyond 2.0 psi or 0.14 bar
 3. Inflate both side main chambers using the screw-on valve adaptor (inside the patch kit) until firm to the touch or to max. pressure of 2.0 psi (0.14 bar). Do not over inflate.

4. Unzip front and rear spray deck covers. Inflate front and rear buoyancy chambers till semi-firm. Do not over inflate. Fasten buckles and tighten webbing to secure the chambers into position. Zip up front and rear spray deck covers.
5. Make sure all air valves are closed and screwed down tightly.

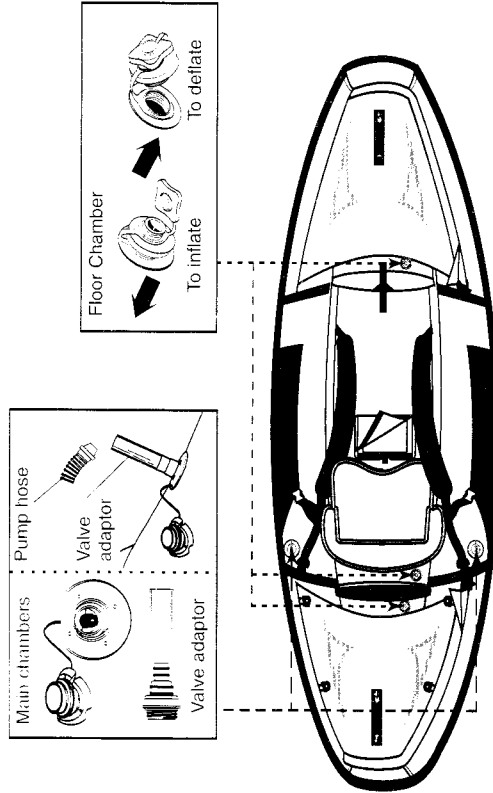

5.2 KNOWING YOUR VALVES

Stearns Pivot™ Kayak uses two types of valves. Type II is used to inflate the floor chambers, Type III is used on Pivot™ main chambers.

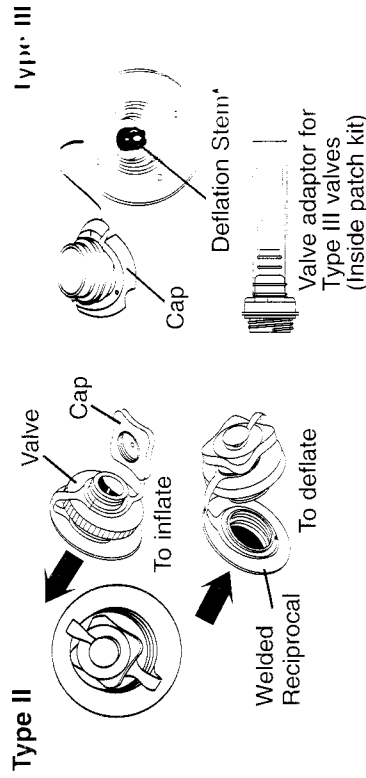

* **Type III Deflation Stem** can be used in three ways. Press and turn 1/4 in. in either direction to lock in closed (up) position or open (down) position. Closed position allows one way air flow for inflation. Open position allows for two way air flow and release until desired effect.

5.3 MAKE SURE CHAMBERS ARE ALIGNED:

1. Each internal air chamber is aligned in relation to the cover which can be adjusted by unzipping the access zippers on the sides of the main chambers
 - A. Relieve air pressure
 - B. Unzip the cover
 - C. Partially inflate
 - D. Realign air chambers, zip cover and inflate chambers
2. All valves are closed tightly, protective caps are reinstalled

CAUTION

Do not over-inflate the kayak. Over-inflation is the primary cause of leaks. Inflate the kayak until most of the wrinkles in the fabric are gone and it feels firm to the touch, but do not exceed 2.0 psi (0.14 bar) in the main air chambers and 1.0 psi (0.07 bar) in the floor chamber.

Water temperature and weather affect the air pressure in the boat. In cold weather your kayak will lose some pressure because the air will contract. If this occurs, you may want to add more air to improve your boat's performance. In hot weather, the air will expand. You must let out some air to prevent the boat from failing from over pressure. Avoid exposing your kayak to extreme temperatures (hot or cold).

Check for proper inflation often. Use your thumb to press on the port (left) and starboard air chambers (right). You should be able to press down 3/4 in. (19 mm). The chamber should feel firm without too much resistance.

If you have difficulty achieving 3/4 in. (19 mm), the chamber could be over inflated.

If you are easily able to press further than 3/4 in. (19 mm), the chamber could be under inflated.

Before paddling, be sure all the kayak's air chambers are properly inflated.

⚠ DANGER

DO NOT overload your kayak which exceeds the rating on the capacity plate. Overloading a kayak can result in loss of control and an unsafe kayak. If your kayak has no capacity plate, contact the selling dealer or the manufacturer.

CAUTION

On warm sunny days, keep the kayak either in water or in shade (if kept inflated on land). This will avoid expanding chambers due to rise in temperature which can result in seam tears, delamination, popped I-Beams and pinholes. Also keep in mind to avoid asphalt, sand, pebbles or concrete in direct sunlight as they radiate high ground heat.

6. UNDERWAY

In all your uses of STEARNS® Inflatable Kayaks, maintain good EPIRB as high priority. Each person should wear an approved personal flotation device. Learn about your boating area. Get official information about the local conditions, tides and currents before kayaking there. Be careful that you do not overestimate your strength, endurance or skill. Be careful never to underestimate the forces of nature.

6.1 Before You Start

Be smart when kayaking and using your equipment.

- Properly inflate your kayak. Do not under or over inflate. Outside temperatures of air and water will drastically change the volume inside chambers. Chambers may need to be adjusted (inflated or deflated) for optimum performance and safety.
- Know the conditions of the environment.
- Tell someone of your travel plans. Check local weather reports before casting off; do not leave the dock area when strong Winds and electrical storms are in the area or predicted to be in the area.
- Secure or store loose items before getting underway.

6.2 Transporting, Carrying and Towing

Your kayak should always be transported dry and in its transporting (carrying) bag. Dry and clean as much as possible before placing boat in carrying bag. Once you have reached your destination, or before long periods of non-use, inflate the kayak and allow it to air dry before storing.

Use care when transporting or storing to avoid sharp points or edges; they will damage your kayak. Use the carrying handles to lift your kayak. Never pull or lift it by the sides or attach any other device to lift or carry it.

⚠ WARNING

Do not exceed the maximum recommended load. The total weight of all persons, gear and fluid capacities must never exceed the maximum load.

6.3 Care and Maintenance

The STEARNS® inflatable kayak is made of very durable materials. However, like anything else, proper care will increase the life of your kayak. Before storing your kayak, make sure it is clean and completely dry before you store it in its carrying bag. It should be deflated and kept out of direct sunlight when stored. Avoid exposure to extreme temperatures (hot or cold). If your kayak is exposed to freezing temperatures while storing, allow it to warm before unfolding. If a zipper is stuck or sticking, do not force it. Use liquid soap and a toothbrush to lubricate the zipper open. Rinse completely.

Never unzip the chamber covers when the kayak is inflated.

Be sure to rinse your kayak with fresh water after every use in salt water and allow it to dry thoroughly before storing.

To store your boat:

1. Wash your kayak using a mild soap or detergent. Never use strong solvents to clean your kayak. Rinse it off with fresh water and allow it to dry thoroughly before storing.
2. Deflate the kayak. Make sure the valves are open so air can flow freely. Dry and clean as much as possible before placing kayak in carrying bag.
3. Fix any punctures before storing your kayak in the carrying bag.

6.4 FOLDING

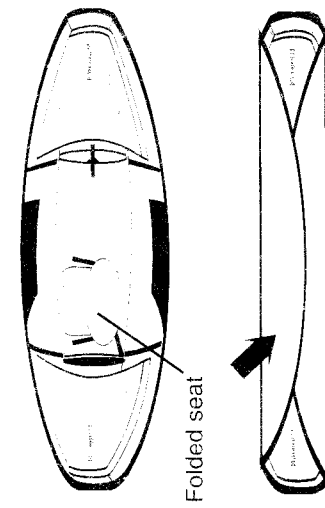

1. Unbuckle three sides of seat, fold in half and place sideways on to the floor. To avoid damage to the seat's foam, seat should lay between the folds when packing or packed separately in the carry bag.
2. Fold sides to height of carry bag.
3. Fold over from front to back to the width of carry bag.

7. REPAIRS

The STEARNS® Pivot™ Kayak comes equipped with a repair kit that includes adhesive and several patches. This can be found in the mesh pocket and should remain with the boat. Making repairs to the mesh tube of the boat may require unzipping the cover and temporarily removing the tube. Always make sure the boat is fully deflated before unzipping the cover. If there is difficulty opening the zipper, refer to the section "Care and Maintenance." When the repair has been completed, be sure the tube is aligned properly in the boat cover and the zipper is completely closed and appropriately locked.

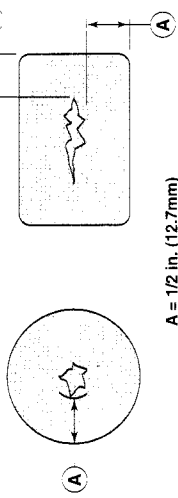

Figure 9

7.1 Repairing Small Punctures and Cuts

1. Cut a patch which is round or with round corners, at least 1/2 in. (12.7 mm) larger than the hole or cut.
2. Use water and/or mild soap to clean the area where the patch will be placed.
3. Make sure all surfaces are dry.
4. Spread a thin layer of glue on both the patch and on the damaged area and let it sit for three to five minutes or until tacky.
5. Press the patch onto the boat, making sure that no air bubbles form.
6. Apply pressure to the patch by placing weight on it. Do not peel back to see if adhesive is holding.
7. Do not inflate the boat for at least twelve hours.

7.2 Repairing Pinholes

1. Inflate the kayak. Locate the pinhole by sponging soapy water over the tube until you see air bubbles.
2. Deflate the kayak. Clean the area around the pinhole and apply a drop of adhesive to the hole once the area is completely dry. A patch may not be necessary.

7.3 Seam Openings

Seam openings are difficult to repair but can be done with certain seam repair adhesives. Contact STEARNS® for more information or ask your local marine shop.

8. TROUBLESHOOTING

This chart will help you find and correct minor problems with your kayak.

Problem	Solution
Slow leak.	Check valve gaskets and make sure the cap tether is not interfering with the seal. The valve gaskets must be closed tightly.
Still leaks slowly.	Check for pinholes. Read section "Repairing Pinholes."
Air valves don't align.	Let air out of both chambers to allow you to shift the inner tube to match up with the valve holes in the cover.
Doesn't inflate completely.	Make sure that the tube is aligned.
The zipper is stuck.	Read "Care and Maintenance" section (6.3) regarding zippers.
Difficulty draining water.	Wipe off excess water with a high absorbing sponge or towel. Kayak dries much quicker inflated, and in a well ventilated area. Do not expose in direct sunlight to dry. Deflate kayak and briefly hang it from the molded handles with seat removed and seating compartment exposed. To avoid mold, do not pack or fold while boat is damp or wet.

9. LIMITED WARRANTY

STEARNS® warrants this product to be free from defects in material or workmanship for a period of one year from the date of purchase. Products that prove to be defective under conditions of normal and proper use during the warranty period because of defective workmanship or faulty material will be replaced or repaired without charge. For warranty service, return product to place of purchase.

STEARNS® shall inspect all warranty claims and in the event of a defect, repair or replace the defective part or entire item, at its option.

This warranty does NOT cover:

Products used for rental, for hire or in professionally guided tours and other uses not considered normal recreational purposes; punctures, cuts and abrasions sustained in normal use; items involved in accidents; items damaged in whitewater mishaps, and other unreasonable uses or improper storage.

STEARNS® shall within (30) days from receipt of an authorized return from purchaser, perform its responsibilities in conformance with this warranty.

HERE ARE NO WARRANTIES WHICH EXTEND BEYOND THE DESCRIPTION OF THE FACE HEREOF. STEARNS SHALL NOT BE HELD LIABLE FOR INCIDENTAL AND CONSEQUENTIAL DAMAGES.

THIS WARRANTY IS INCLUSIVE IN LIEU OF ALL OTHER WARRANTIES.

This warranty gives you specific legal rights and you may also have other rights that vary from state to state.

Stearns® Inc.

**1100 Stearns Drive
Sauk Rapids, MN 56379
USA**

320-252-1642

www.stearnsinc.com